

HKK 230V 1.5 – 230 3 8

Kompaktaggregat 230V, 1.5kW, 230bar
Compact Powerpack 230V, 1.5kW, 230bar

Schaltplan / Hydraulic circuit

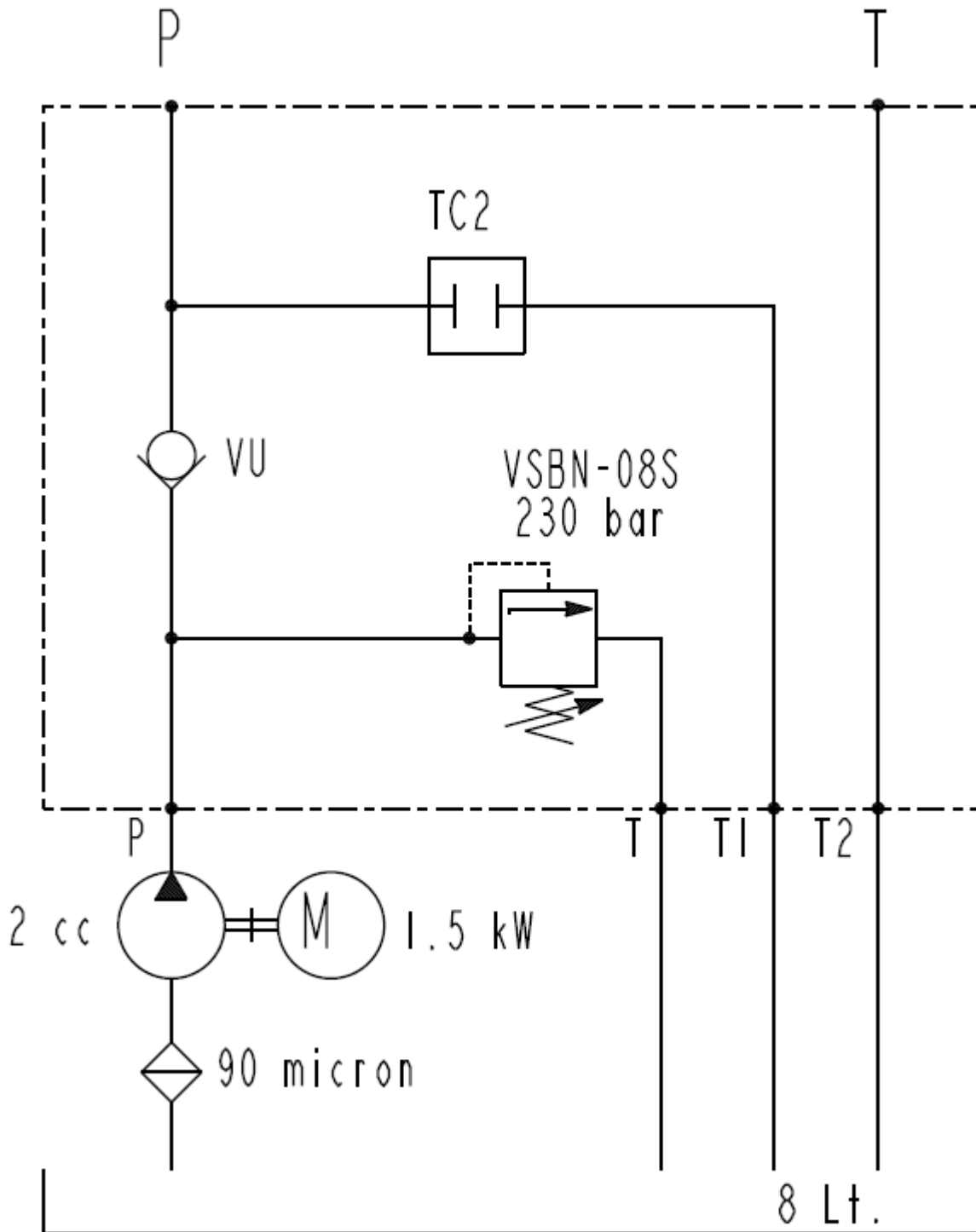

HKK 230V 1.5 – 230 3 8

Kompaktaggregat 230V, 1.5kW, 230bar
Compact Powerpack 230V, 1.5kW, 230bar

HANSA FLEX

Abmessungen / Dimensions

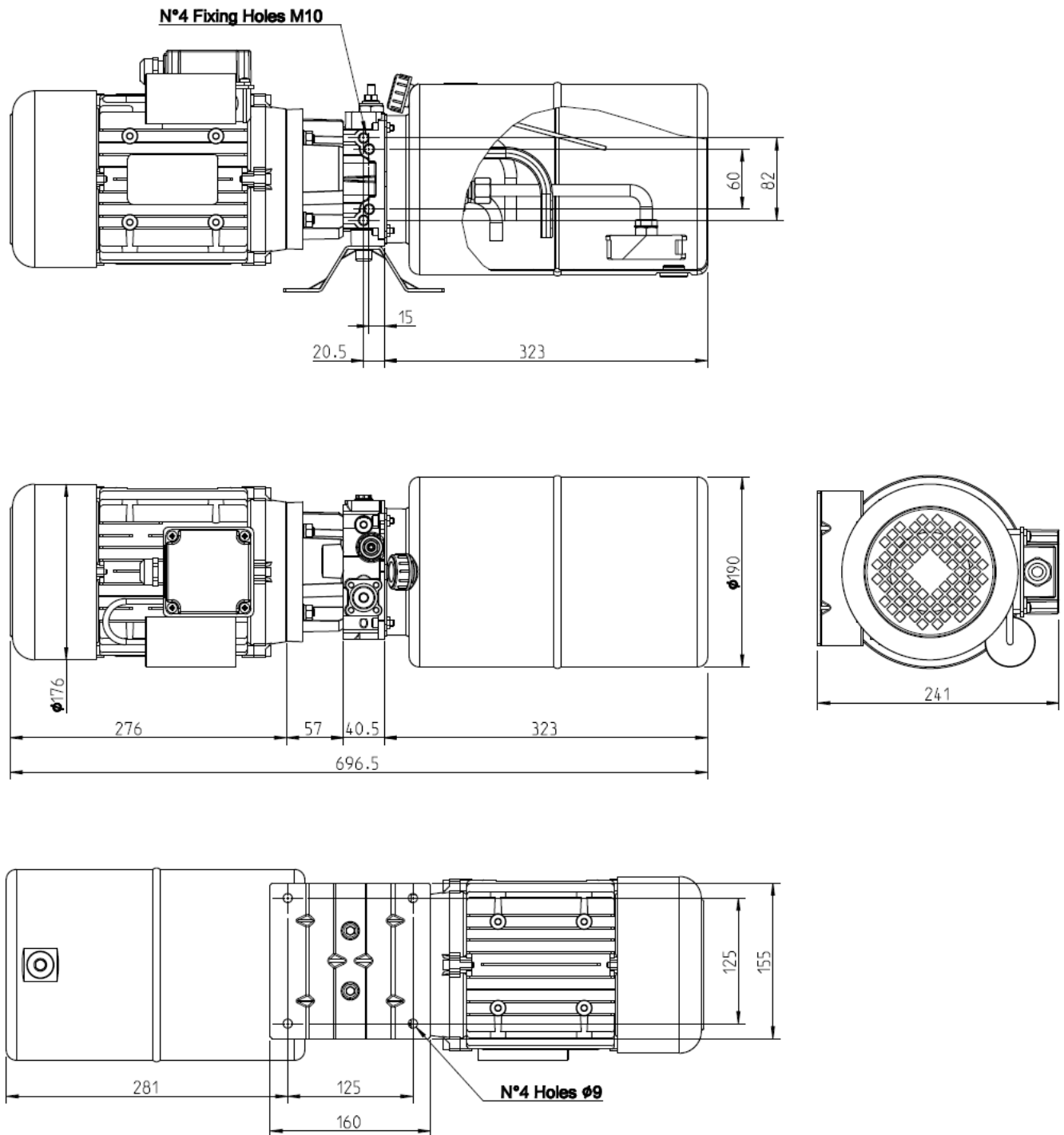

HKK 230V 1.5 – 230 3 8

Kompaktaggregat 230V, 1.5kW, 230bar
Compact Powerpack 230V, 1.5kW, 230bar

HANSA FLEX

Stückliste / Parts list

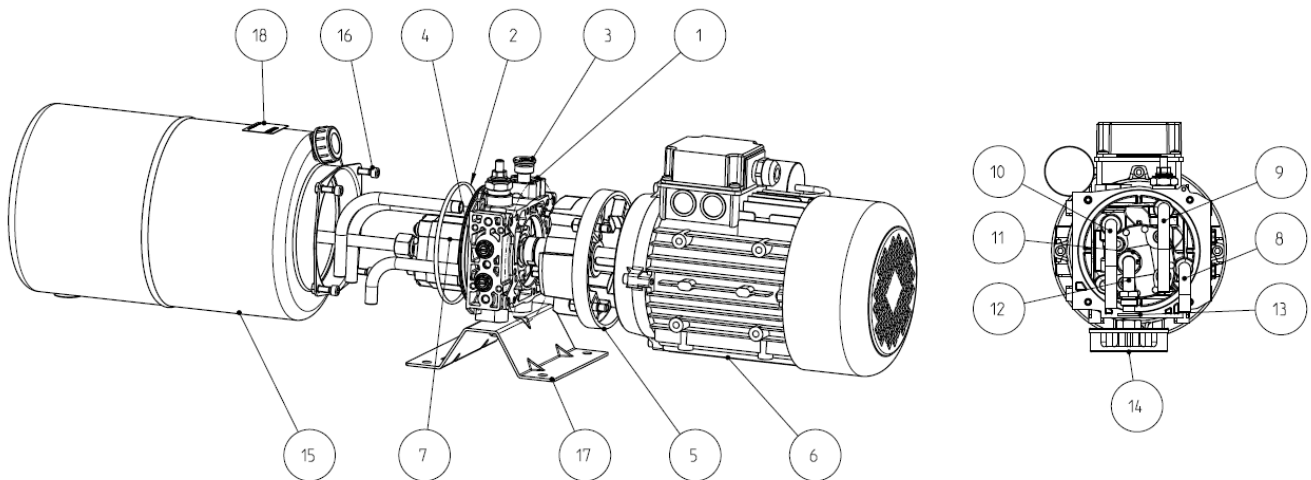

18	NAMEPLATE TARGHETTA	CA ID CA ID	1
17	KIT-G07-SUPPORTO-X-K-VITI KIT-G07-SUPPORTO-X-K-VITI		1
16	SOCKET HEAD SCREW ZYLINDERSCHRAUBE	ISO4762-M6X16-8.8-CM& ISO4762-M6X16-8.8-CM&	4
15	OIL RESERVOIR SERBATOIO OLIO	KIT-S04V-CILINDRICO-& KIT-S04V-CILINDRICO-&	1
14	FIL PIATTO D80 LAM3/8F 15L 90M FR1.01329 FIL PIATTO D80 LAM3/8F 15L 90M FR1.01329		1
13	COPPER-SEAL. RING RONDELLA IN RAME	D17.0XD23.0X1.5 D17.0XD23.0X1.5	1
12	PIPE TUBO	SUCTION M A L D12 L18 SUCTION M A L D12 L18	1
11	FITTING ANSCHLUSSSTUTZEN	DIN2353 L G3/8 B T12 DIN2353 L G3/8 B T12	1
10	PIPE TUBO	RETURN M L190 M12X1 RETURN M L190 M12X1	1
9	PIPE TUBO	RETURN M D L190 M12X1 RETURN M D L190 M12X1	1
8	PIPE TUBO	RETURN M D L123 M12X1 RETURN M D L123 M12X1	1
7	KIT13 POMPA.LD 2.0CC VITI M8X75 KIT13 POMPA.LD 2.0CC VITI M8X75		1
6	407M-1.5KW -230-50-40MF-B14-90 407M-1.5KW -230-50-40MF-B14-90		1
5	CARRIER TRASCINATORE	KIT-F16-TR.-IN-ALLUM& KIT-F16-TR.-IN-ALLUM&	1
4	GUARD PLUG SCHUTZSTOPFEN	P G1/4 TMGABM RED P G1/4 TMGABM RED	2
3	DUMMY PLUG FALSA CARTUCCIA	TC2 V096004 TC2 V096004	1
2	O-RING O-RING	NP00160-110.72X3.53-& NP00160-110.72X3.53-&	1
1	A12/20 K GR.1 VSBN.90-250BAR VU VE12.7 A12/20 K GR.1 VSBN.90-250BAR VU VE12.7		1
Pos.	Description		Qty